

Example of lubrication in oil bath

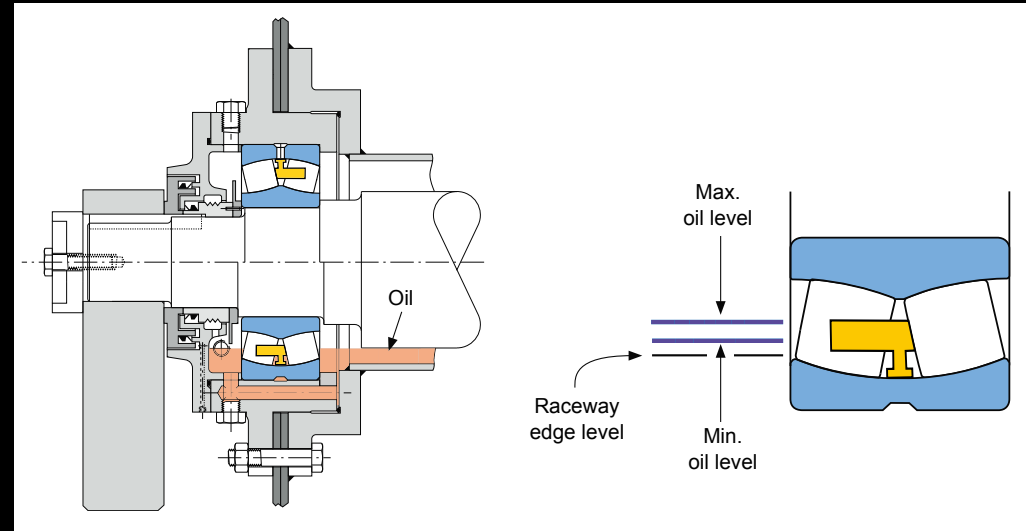

Example of lubrication with circulation pump

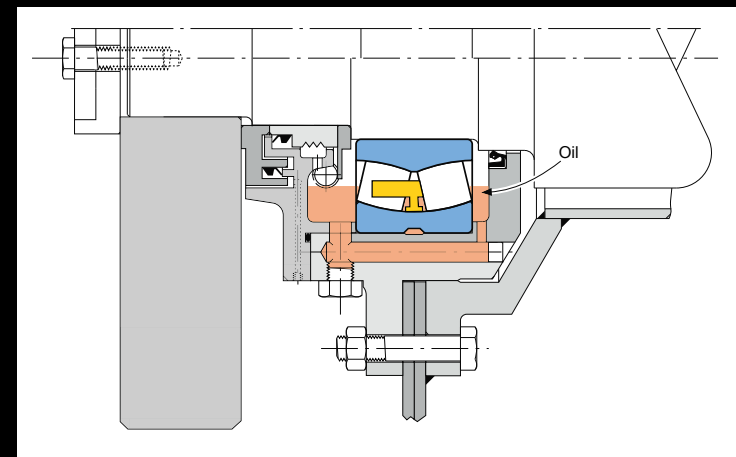

Example of ZKL spherical roller bearing vibration applications

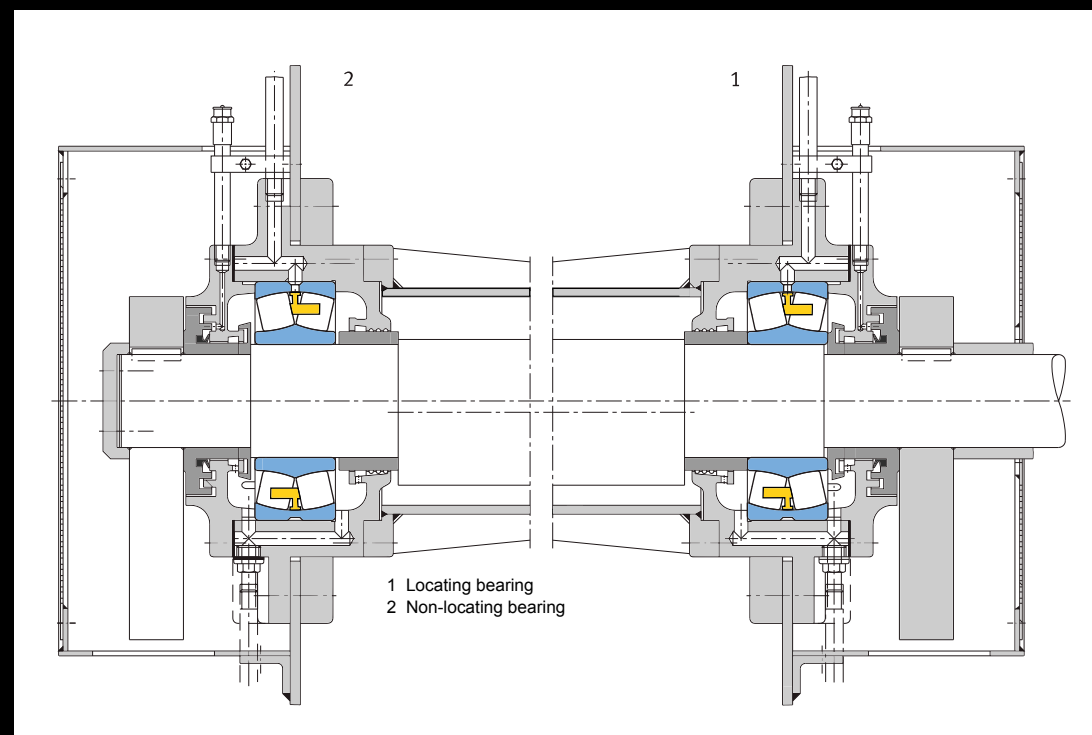

ZKL, a.s.
 Jednovnická 8, Brno
 Czech Republic
 Telephone: +420 544 135 120
 E-mail: head@zkl.cz



WWW.ZKL.EU

ZKL Bearings CZ, a.s.
 Líšeňská 45, Brno
 Czech Republic
 Telephone: +420 544 135 131
 E-mail: zkl@zkl.cz

History is the base for the present and a challenge for the **future**.



ZKL GROUP



**ZKL SPHERICAL ROLLER
 BEARINGS FOR VIBRATION
 MACHINERY AND EQUIPMENT**

ZKL spherical roller bearings for vibration machinery and equipment

For increased reliability in environments with increased vibration and impact levels ZKL produces double-row spherical roller bearings of 223 series, or 233 series, with identification EMHD2.

Structure

These are bearings with higher load-bearing capacity and symmetrical spherical rollers, a single-component massive brass case on the outer race. The bearings are provided with standard radial clearance within the scope of C4 and tapered tolerances of the connection dimensions of the bore (in the case of bearings with cylindrical bore) and outer diameter. The outer races are as a standard equipped with a perimeter groove with three lubrication holes W33. The increased radial clearance and the way of the cage guidance and the groove with lubrication holes are not specifically identified for these bearings as they are included in the combined identification of D2.

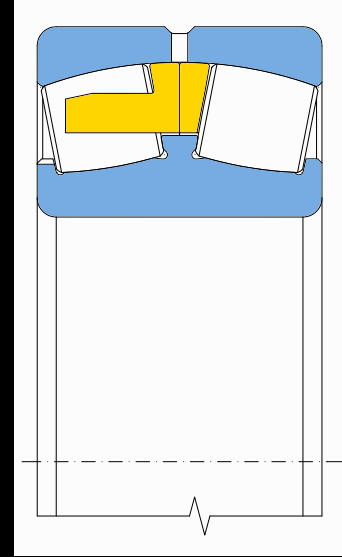

New structure
22308 – 19 EMHD2

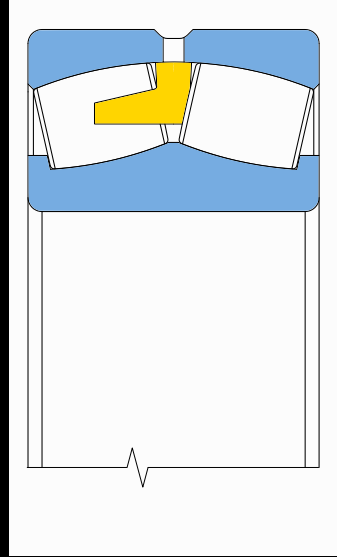

Old structure MD1

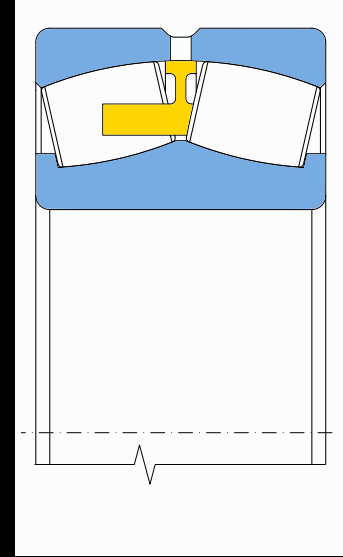

New structure
22320 – 36 EMHD2

Dimensions and tolerances

Tolerances of bore dimensions and outer diameter of spherical roller bearings by ZKL for vibration applications									
Diameter of the bore		Tolerance class		Outer diameter		Tolerance class		Tolerance class	
d	mm	Normal		For bearings in vibration applications		D	mm	Normal	
		min	max	min	max			min	max
30 do 50	0	-12	0	-7	0	80 do 150	0	-15; (-18)	-5
50 do 80	0	-15	0	-9	0	150 do 180	0	-25	-5
80 do 120	0	-20	0	-12	0	180 do 315	0	-30; (-35)	-10
120 do 180	0	-25	0	-15	0	315 do 400	0	-40	-13

The principal dimensions of spherical roller bearings by ZKL designed for vibration machines comply with ISO 15-1998 standard.

Tolerance values comply with ISO 492-2002 standard.

Spherical roller bearings by ZKL for vibration applications are made with higher precision than standard P0.

Inner Radial Clearance

Bearings for vibration applications, series 223 and 233, are made as a standard with inner radial clearance C4. The bearing clearance is included in D2.

The inner radial clearance value C4 complies with ISO 5753-1991 standard.

Inner radial clearance of spherical roller bearings					
Bore diameter d	Cylindrical bore		Tapered bore		C4
	min	max	min	max	
30	40	60	80	65	85
40	50	75	100	80	100
50	65	90	120	95	120
65	80	110	145	120	150
80	100	135	180	140	180
100	120	160	210	170	220
120	140	190	240	200	260
140	160	220	280	230	300
160	180	240	310	260	340
180	200	260	340	290	370
200	225	290	380	320	410
225	250	320	420	350	450

Misalignment

The structure of spherical roller bearings by itself allows for their tipping i.e. the misalignment may be balanced by tipping of the outer race in relation to the inner race without any negative effect on the bearing.

Tipping angle of bearing series 223 and 233 is 2°.

The actual application determines whether this value may be used to the full or not.

If the misalignment position changes in relation to the outer race, for example in

- vibration sieves with rotating imbalance where the shaft sag rotates with the shaft rotation
- support rolls of paper mill machines where the stationary shaft sags,

then the operating bearing slips. As this is associated with heat generation, the tipping of the inner race in relation to the outer race is not recommended to exceed 0.1°. Higher tipping values than 0.2° to 0.3° are also possible, though, if adequate lubrication and cooling are provided.

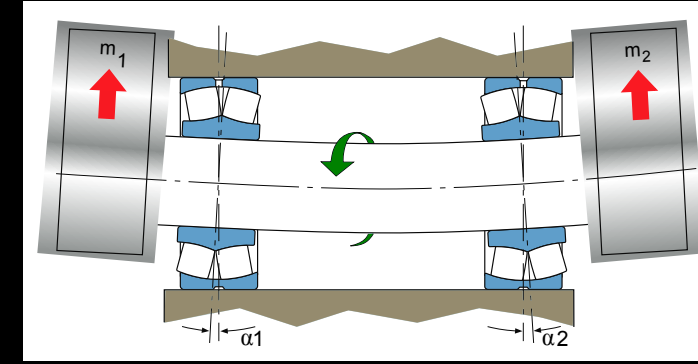

Effect of Operation Temperature on Bearing Materials

All ZKL spherical roller bearings are subject to special heat treatment allowing their use at operation temperatures up to 200 °C without impermissible dimensional changes. The corresponding additional identification S₁ is not used.

Axial Load

Double-row spherical roller bearings under radial load may transfer considerable axial loads. In the case of the axial to radial load ratio $F_a / F_r > e$ (the coefficient shown in the tables) grease re-lubrication interval shortening is recommended.

Lubrication

Example of grease lubrication

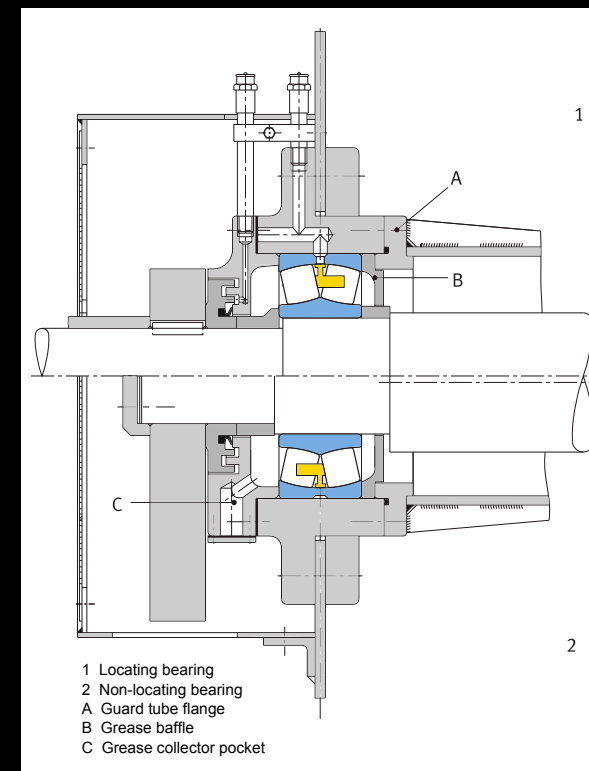

Product Table

Principal dimensions						Basic load-bearing capacity		Limit fatigue load P _v	Limit rotation frequency for lubrication		Bearing type		Connection dimensions			Weight		Clamping case	Folding case	Locknut	Coefficients				
d	D	B	r _e	a	b	C _d	C _{or}		Grease	Oil	Cylindrical bore	Tapered bore	d _s	D _s	r _s	~	K				e	Y ₁	Y ₂	Y ₀	
mm						kN		kN	min ⁻¹				mm			kg									
40	90	33	1.5	3	5.5	154	160	20	4100	5100	22308EMHD2**	22308EKMHD2	49	81	1.5	1.07	1.05	H2308	AH2308	KM9	0.36	1.8	2.6	1.8	
50	110	40	2	3	5.5	220	238	29	3300	4000	22310EMHD2**	22310EKMHD2	60	100	2	1.92	1.88	H2310	AH2310X	KM11	0.36	1.9	2.7	1.8	
55	120	43	2	3	5.5	253	279	34	3000	3800	22311EMHD2**	22311EKMHD2	65	110	2	2.44	2.39	H2311	AH2311X	KM12	0.35	1.9	2.8	1.9	
60	130	46	2.1	3	5.5	304	315	38	2800	3600	22312EMHD2**	22312EKMHD2	72	118	2	3.03	2.97	H2312	AH2312X	KM13	0.35	1.9	2.9	1.9	
65	140	48	2.1	3	5.5	329	351	42	2600	3400	22313EMHD2**	22313EKMHD2	77	128	2	3.64	3.56	H2313	AH2313	KM15	0.34	2	3	2	
70	150	51	2.1	3	5.5	376	402	48	2400	3100	22314EMHD2**	22314EKMHD2	82	138	2	4.40	4.31	H2314	AH2314X	KM16	0.34	2	3	2	
75	160	55	2.1	4.5	8.3	436	489	57	2300	3000	22315EMHD2**	22315EKMHD2	87	148	2	5.48	5.36	H2315	AH2315X	KM17	0.33	2	3	2	
80	170	58	2.1	4.5	8.3	487	551	63	2200	2800	22316EMHD2**	22316EKMHD2	92	158	2	6.51	6.37	H2316	AH2316X	KM18	0.33	2	3	2	
85	180	60	3	4.5	8.3	530	603	68	2000	2600	22317EMHD2**	22317EKMHD2	99	166	2.5	7.48	7.34	H2317	AH2317X	KM19	0.32	2.1	3.1	2	
90	190	64	3	4.5	8.3	590	673	74	1900	2400	22318EMHD2**	22318EKMHD2	104	176	2.5	8.89	8.70	H2318	AH2318X	KM20	0.33	2.1	3.1	2	
95	200	67	3	4.5	8.3	665	744	81	1800	2300	22319EMHD2**	22319EKMHD2	109	186	2.5	10.30	10.00	H2319	AH2319X	KM21	0.33	2.1	3.1	2	
100	215	73	3	4.5	8.3	750	842	90	1700	2200	22320EMHD2**	22320EKMHD2	114	201	2.5	12.8	12.6	H2320	AH2320X	KM22	0.33	2	3	2	
110	240	80	3	6	11.1	868	1000	103	1500	1900	22322EMHD2**	22322EKMHD2	124	226	2.5	17.9	17.5	H2322	AH2322X	KM25	0.33	2.1	3.1	2	
110	240	92.1	3	6	11.1	900	1160	120	1400	1800	23322EMHD2**	-	124	226	2.5	20.5	-	-	-	-	-	0.38	1.8	2.6	1.7
120	260	86	3	6	11.1	1020	1180	119	1400	1800	22324EMHD2**	22324EKMHD2	134	246	2.5	22.9	22.5	H2324	AH2324X	KM27	0.33	2.1	3.1	2	
130	280	93	4	7.5	13.9	1180	1380	136	1300	1700	22326EMHD2**	22326EKMHD2	148	262	3	28.0	27.4	H2326	AH2326X	KM29	0.33	2.1	3.1	2	
140	300	102	4	7.5	13.9	1320	1560	150	1200	1500	22328EMHD2**	22328EKMHD2	158	282	3	34.9	34.2	H2328	AH2328X	KM31	0.34	2	3	2	
150	320	108	4	9	16.7	1520	1850	175	1000	1400	22330EMHD2**	22330EKMHD2	168	302	3	42.3	41.5	H2330	AH2330X	KM33	0.33	2	3	2	
160	340	114	4	9	16.7	1690	2090	194	1000	1300	22332EMHD2**	22332EKMHD2	178	322	3	52.0	51.0	H2332	AH2332	KM36	0.33	2	3	2	
170	360	120	4	9	16.7	1780	2280	179	950	1250	22334EMHD2**	22334EKMHD2	188	342	3	59.1	57.8	H2334	AH2334	KM38	0.34	2	3	2	
180	380	126	4	12	22.3	1950	2530	227	900	1200	22336EMHD2**	22336EKMHD2	198	362	3	68.7	67.2	H2336	AH2336	KM40	0.33	2.1	3.1	2	

** NEW FORCE

** NEW FORCE

The following equation applies to bearings re-lubricated with an automatic lubrication unit:

$$m_1 = 0.00004 \cdot D \cdot B$$

Where:

- m₁ – required lubricant quantity
- D – external diameter of bearing
- B – bearing width

Initial lubricant quantity and re-lubrication quantity for spherical roller bearings in vibration applications

Bear-ing	Initial Lubricant quantity	Re-lubrication quantity for speed min-1 (re-lubrication after 50 operation hours)															
		500	600	700	800	900	1 000	1 200	1 400	1 600	1 800	2 000	2 200	2 400	2 600	2 800	3 000
22308	16	5	5	5	5	5	5	5	5	5	5	5	5	5	5	5	5
22309	22	5	5	5	5	5	5	5	5	5	5	5	5	5	5	5	10
22310	27	5	5	5	5	5	5	5	5	5	5	5	5	10	10	10	10
22311	43	5	5	5	5	5	5	5	5	5	5	10	10	10	10	15	15
22312	50	5	5	5	5	5	5	5	5	5	10	10	10	10	15	15	
22313	56	5	5	5	5	5	5	5	10	10	10	10	15	15	20		
22314	76	5	5	5	5	5	5	10	10	10	15	15	20	25			
22315	91	5	5	5	5	5	5	10	10	10	15	20	25				
22316	100	5	5	5	10	10	10	10	10	15	20	25					
22317	130	5	5	10	10	10	10	10	15	20	25	35					
22318	145	10	10	10	10	10	10	15	20	25	30	40					
22319	180	10	10	10	10	10	15	15	25	35	45						
22320	185	10	10	10	10	15	15	20	30	40							
22322	270	10	10	15	15	20	20	30	50	70							
22324	330	15	15	20	25	30	35	55	85								
22326	420	15	20	20	25	35	40	65									
22328	525	20	25	30	35	45	60	100									
22330	630	25	30	40	50	65	90										
22332	725	25	35	45	60	80	100										